

Marca/Modello Machine brand name Marke Maschine Marque de la machine	Codice Ref. Nr. Re. Nr. Ref. Nr.	Disegno Draw Zeichnung Dessin	Peso Weight Gewicht Poids gr	Accessori Accessories Zubehör Accessoires
Molle tipo KONGSKILDE				
32x10 Senza vomere	VIB12		2.700	VIB49
32x10 Con vomere	VIB21		3.000	VIB49
32x12 senza vomere	VIB13		3.200	VIB49
32x12 con vomere	VIB21A		3.500	VIB49
Gare posteriore alta 25X8 senza foro	VIB12C		1.120	VIB50
Gare posteriore alta 25X8 con foro	VIB12A		1.120	VIB50
GARE ANTERIORE ALTA 25X8	VIB29		1.000	VIB50
Molla diritta senza foro	VIB39		940	-
JACKPOT 32X12 CON VOMERINO	VIB51		3.110	-

Marca/Modello Machine brand name Marke Maschine Marque de la machine	Codice Ref. Nr. Re. Nr. Ref. Nr.	Disegno Draw Zeichnung Dessin	Peso Weight Gewicht Poids gr	Accessori Accessories Zubehör Accessoires
Molle tipo KONGSKILDE VF				
150X10 CON VOMERE	VIB52		1.500	-
45X12 A 1 FORO	VIB53		3.500	-
45X12 A 2 FORI	VIB54		3.500	-
Spirale per molla BF 150X10	VIB69		1.014	-
Rinforzo Molla Flex 32x10	VIB14A		1.450	VIB49
Rinforzo tipo KONGSKILDE -RAU 32x10 con occhiello	VIB15		1.450	VIB49
Rinforzo Molla Flex 45x12 con occhiello	VIB65		2.580	-

Marca/Modello Machine brand name Marke Maschine Marque de la machine	Codice Ref. Nr. Re. Nr. Ref. Nr.	Disegno Draw Zeichnung Dessin	Peso Weight Gewicht Poids gr	Accessori Accessories Zubehör Accessoires
Molla Rompitraccia 32x10 senza vomere	VIB30A		1.900	VIB06
Rinforzo rompitraccia 32x10	VIB31		855	-
Molla Germinator 32x10	VIB63		1.670	VIB64
Molla tipo Chisel 55x20 senza vomere	VIB70		16.800	EST08
Molla tipo Chisel 55x25 senza vomere	VIB71			EST08

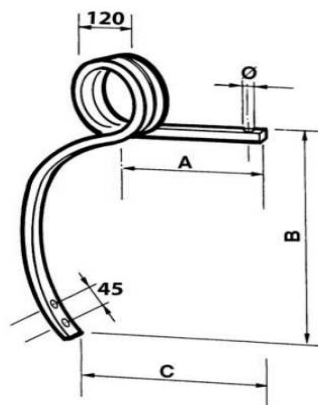

Marca/Modello Machine brand name Marke Maschine Marque de la machine	Codice Ref. Nr. Re. Nr. Ref. Nr.	Disegno Draw Zeichnung Dessin	Peso Weight Gewicht Poids gr	Accessori Accessories Zubehör Accessoires
Molla a Balestra 45x7 a 2 1/2 fogli con rinforzo - A= 480 B= 200 C= 107 con vomere	VIB73		2.960	VIB75 EST04
Molla a Balestra 45x7 a 3 fogli con rinforzo - A= 520 B= 215 C= 113 con vomere	VIB74		7.450	VIB75 EST04
Molla a Balestra 45x7 a 4 fogli con rinforzo - A= 530 B= 225 C= 120 con vomere	VIB74A		9.480	VIB75 EST04

Molle tipo quadro dx+sx



Il disegno rappresenta una molla sinistra

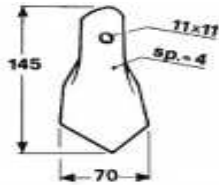
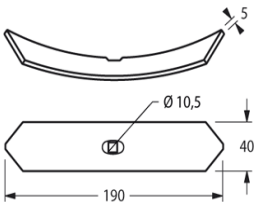
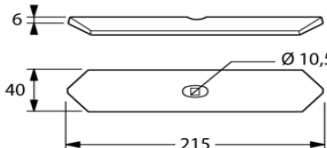
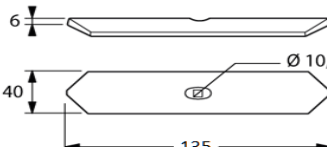
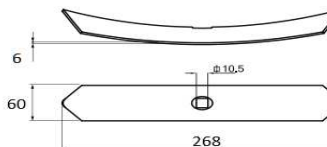

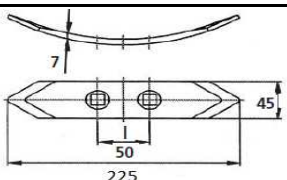
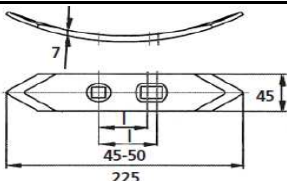
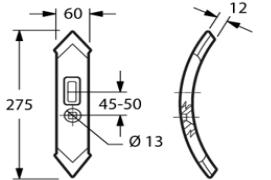
Codice Ref. Nr. Re. Nr. Ref. Nr.	Quadro Square Bild Carrè	A	B	C	Ø FORO
EST51	25x25	240	455	365	13
EST28	30x30	280	535	365	17
EST29	25x25	240	520	310	13
EST30	30x30	280	635	310	17

Vomerino a zampa d'oca tipo KONGSKILDE 70X4X145	VIB55		350	-
Vomerino Reversibile 40x5 l. 190	VIB06		250	-
Vomerino Reversibile 40x8 l. 210	VIB06A		450	-
Vomerino Reversibile 60X6 l. 260	VIB06B		650	-
Vomerino Reversibile 40X5 l. 135	VIB06D		150	-
Vomerino Reversibile 40X6 l. 215	VIB06C		360	-
Vomere reversibile per Germinator	VIB64		150	VIB07
Vomere reversibile per 45x12	VIB66		660	-
Vomere reversibile 40x16x270 - int. 45 fori 12 per molle quadro	EST33		770	-
Vomere reversibile 60x12x285 - int. 45-65 foro 13 asola 13x35 per molle quadro	EST03		1.340	-
Vomerino reversibile per molle a balestra - fori 11	VIB75		470	-
Vomerino reversibile per molle a balestra - fori 11	VIB75A		480	-
Vomerino reversibile stampato	EST03		1.300	VIB07

Marca/Modello Machine brand name Marke Maschine Marque de la machine	Codice Ref. Nr. Re. Nr. Ref. Nr.	Disegno Draw Zeichnung Dessin	Peso Weight Gewicht Poids gr	Accessori Accessories Zubehör Accessoires
Vomere reversibile KONGSKILDE	VIB76		1.400	VIB07C
VOMERE doppio cuore per molla chisel	EST18		3.110	-
Vomere reversibile foro 13	EST07		1.200	-
Vomere reversibile foro 13 per molla quadra a doppia spira	EST07A		1.200	-
Vomere reversibile chisel sp. 15	EST08		2.150	-
Vomere reversibile chisel sp. 12 fori 13	EST52		2.000	-
VOMERE doppio cuore per molla chisel	EST18		3.110	-
VOMERE doppio cuore per molla chisel largo 180	EST18B		3.500	-

L	H	COD.	
120	120	VIB01	
140	135	VIB19	
160	145	VIB20	
180	150	VIB56	
200	165	VIB02	
220	165	VIB57	
240	190	VIB03	
260	210	VIB58	
300	230	VIB59	
L	H	COD.	
220	210	VIB60	
250	255	VIB61	

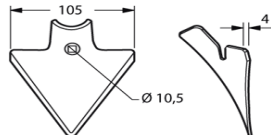
L	H	FORI		COD.	
130	255	6,5			VIB08
145	275	9			VIB09
160	255	6,5			VIB10
175	320	6,5			VIB62

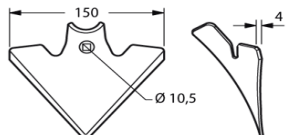
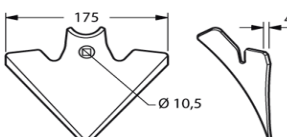
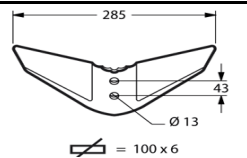
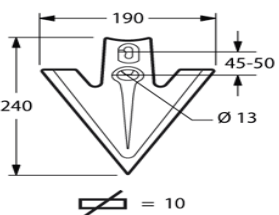
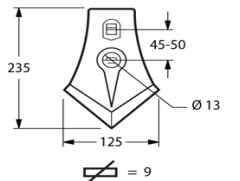
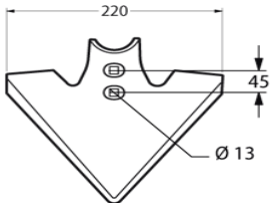
Marca/Modello Machine brand name Marke Maschine Marque de la machine	Codice Ref. Nr. Re. Nr. Ref. Nr.	Disegno Draw Zeichnung Dessin	Peso Weight Gewicht Poids gr	Accessori Accessories Zubehör Accessoires
Vomere a lancia 105x4 foro 11X11 H=117	VIB04		220	VIB07
Vomere a lancia tipo gaspardo rif. Or. 23440039	GA150		-	-
Vomere a lancia 150x4 foro 11X11 H=155	VIB05		390	VIB07
Vomere a lancia 175x4 foro 11X11 H=155	VIB18		440	VIB07
KONGSKILDE con alette	VIB76A		1.200	VIB07C
Vomerino a lancia 190X240	EST05		1.800	VIB07C
Vomerino a lancia 240X280	EST06		2.000	VIB07C
Vomerino a cuore	EST04		1.200	VIB07
Vomerino Adige spessore 8	VIB18		1.360	-

Marca/Modello Machine brand name Marke Maschine Marque de la machine	Codice Ref. Nr. Re. Nr. Ref. Nr.	Disegno Draw Zeichnung Dessin	Peso Weight Gewicht Poids gr	Accessori Accessories Zubehör Accessoires
Vomere tipo Belgio	EST48		-	-
Vomere a saldare 240X240	EST01		1.050	-
Vomere a saldare 270X270	EST02		1.150	-
Beltrami	EST49		1.500	-
Calderoni	EST50		1.850	-
Schiavina, Nuova Comas	EST09		1.380	-
Schiavina, Nuova Comas	EST10		1.850	-
Vomerina non forata 130X10	EST11		1.380	-
Vomerina non forata 160X12	EST12		1.850	-

Marca/Modello Machine brand name Marke Maschine Marque de la machine	Codice Ref. Nr. Re. Nr. Ref. Nr.	Disegno Draw Zeichnung Dessin	Peso Weight Gewicht Poids gr	Accessori Accessories Zubehör Accessoires
Vomere per Pegoraro, Passardi, Alpego 60x18 l. 450	EST16		-	-
Vomere per Pegoraro, Passardi, Alpego 70x18 l. 435	EST16A		-	-
Vomere per Pegoraro, Passardi, Alpego 80x20 l. 500	EST25		-	-
Vomere per Pegoraro, Passardi, Alpego 100x14 l. 435	EST25A		-	-
Vomere per Pegoraro, Passardi, Alpego 100x16 l. 485	EST26		-	-
Vomere per Pegoraro, Passardi, Alpego 70x20 l. 470	EST27		-	-
Drill Point	EST23		660	-
Drill Point	EST23A		930	-

Marca/Modello Machine brand name Marke Maschine Marque de la machine	Codice Ref. Nr. Re. Nr. Ref. Nr.	Disegno Draw Zeichnung Dessin	Peso Weight Gewicht Poids gr	Accessori Accessories Zubehör Accessoires
Staffa Monolama 50x6 per 32x10 e 32x10	VIB16		250	-
Staffa Bilama 50x6 per 32X10 e 32X12	VIB17		250	-
Staffa per VIB12A 40x5	VIB16A		180	-
Staffa monolama 70X10 per molle 45x12 telaio 50x50	VIB67		850	-
Staffa bilama 70X10 per molle 45x12 telaio 50x50	VIB68		920	-
Staffa molla flex senza rinforzo per telaio 50X12	VIB49		250	-
Staffa per molle gare per telaio 40X10	VIB50		160	-
Staffa per molle CHISEL per telaio 100X100	VIB72		4.430	-
Staffa Monolama per molla tipo quadro 25 telaio 80x80	EST31		250	-
Staffa Monolama per molla tipo quadro 30 telaio 80x80	EST32		250	-

Bulloneria
Special bolts
Schrauben
Boulonnerie

Descrizione Description Beschreibung Description	Codice Ref. Nr. Re. Nr. Ref. Nr.	Peso Weight Gewicht Poids
VITI CON TESTA A OLIVA R8.8 CON DADO E RONDELLA 10X38 passo 1.5	VIB07	0,05
VITI CON TESTA A OLIVA R8.8 CON DADO E RONDELLA 10X45 passo 1.5	VIB07A	0,05
VITI CON TESTA A OLIVA R8.8 CON DADO E RONDELLA 12X48 passo 1.5	VIB07B	0,06
VITI CON TESTA A OLIVA R8.8 CON DADO E RONDELLA 12X60 passo 1.5	VIB07C	0,07
VITI TSPQST R8.8 CON DADO ESAGONALE PER DENTI ESTIRPATORI 12X60 passo 1.5	BUL33	0,08

Marca/Modello Machine brand name Marke Maschine Marque de la machine	Codice Ref. Nr. Re. Nr. Ref. Nr.	Disegno Draw Zeichnung Dessin	Peso Weight Gewicht Poids gr	Accessori Accessories Zubehör Accessoires
Braccio estirpatore corto 50X20 B=190 C= 380	EST34		4.500	-
Braccio estirpatore corto 50X25 B=190 C= 380	EST35		6.000	-
Braccio estirpatore corto 60X30 B=190 C= 380	EST36		8.000	-
Braccio estirpatore lungo 50X20 A= 700 B=190 C= 380	EST37		8.500	-
Braccio estirpatore lungo 50X25 A= 700 B=190 C= 380	EST38		10.500	-
Braccio estirpatore lungo 60X30 A= 700 B=190 C= 380	EST39		15.000	-
Ancora tedesca int. 70 A=720 B= 60 C0 25 FORI 13	EST40		8.200	-
Ancora tedesca int. 70 A=820 B= 60 C0 25 FORI 13	EST41		9.700	-
Ancora estirpatore media A= 500 B= 290	EST42		6.300	-
Ancora estirpatore pesante A= 570 B= 300	EST43		8.500	-
Nasello per ancora estirpatore	EST44		-	-
Ciarpa per ancora estirpatore 50x20 fil. 20MA	EST45		-	-
Ciarpa per ancora estirpatore 50x25 fil. 20MA	EST46		-	-
Ciarpa per ancora estirpatore 60x30 fil. 22MA	EST47		-	-

Molla per estirpatori con ganci fissi opposti

Ø filo	L	D	Disegno	n. spire	COD.
8	204	40		18	ML001
12	346	58		22	ML002
12	359	62		23	ML003

Molla per estirpatori con occhio girevole

Ø filo	L	D	Disegno	n. spire	COD.
11	390	51		27	ML004
11	420	51		29	ML005
12	417	60		28	ML006
12	460	60		30	ML007
10	335	52		21	ML008
11	337	52		19	ML009