

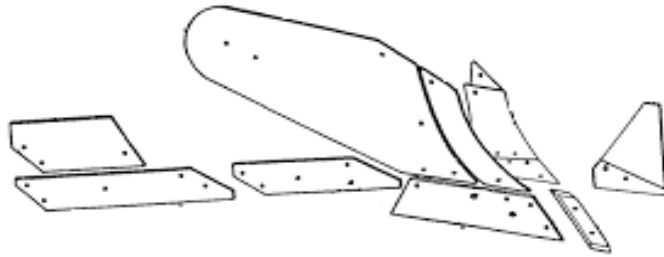

Ricambi per aratri
Spare Parts for ploughs
Ersatzeile für pfluge
Pieces detachees pour charrues

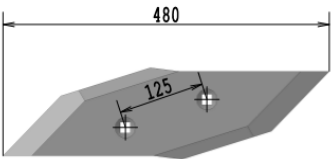

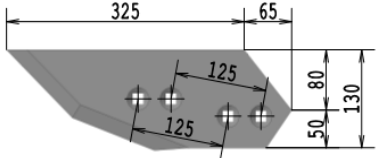

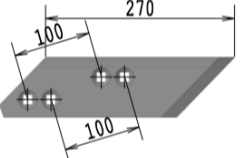
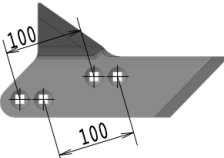
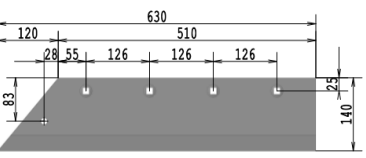
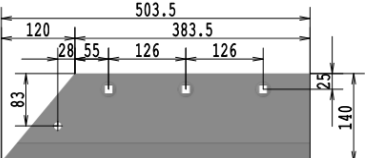
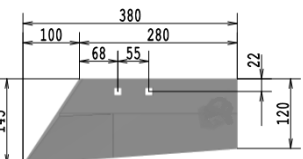



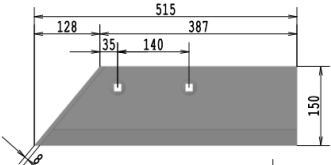

Marca/Modello	Rif. Originale	Codice	Disegno	Peso	Accessori
Machine brand name	Original code	Ref. Nr.	Draw	Weight	Accessories
Marke Maschine	Original-Code	Re. Nr.	Zeichnung	Gewicht	Zubehör
Marque de la machine	Code original	Ref. Nr.	Dessin	Poids	Accessoires
				gr	

ER.MO

PUNTA PER CORPO 4ML - SPESSORE 15	CA003AD-GS11 CA003AS-GS11	VA007 DX VA016 SX		4.000	BUL14
PUNTA PER CORPO 4ML - SPESSORE 15	CA005AD-B100 CA005AS-B100	VA017 DX VA018 SX		4.350	BUL14
PUNTA PER VOMERO A22/A22B - ERMO B57	CA001AD CA001AS	VA035 DX VA036 SX		-	BUL31
PUNTA PER VOMERO A22/A22B - ERMO B58	CA002AD CA002AS	VA037 DX VA038 SX		-	BUL31
VOMERO	CA094AS-A22B CA094AD-A22B	VA039 DX VA040 SX		-	BUL31
VOMERO	CA093AS-A22 CA093AD-A22	VA041 DX VA042 SX		-	BUL31
VOMERE PER AVANVOMERE - SPESSORE 8	CA054AD-A29 CA054AS-A29	VA011 DX VA012 SX		1.700	BUL31
VOMERE PER AVANVOMERE - SPESSORE 8	CA106AD-A30 CA106AS-A31	VA033 DX VA034 SX		3.000	-
VOMERE PER CORPO 4ML - SPESSORE 12	CA033AD-GS9 CA0033AS-GS9	VA013 DX VA014 SX		8.000	-

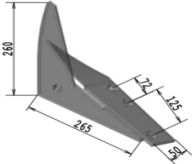
Marca/Modello	Rif. Originale	Codice	Disegno	Peso	Accessori
Machine brand name	Original code	Ref. Nr.	Draw	Weight	Accessories
Marke Maschine	Original-Code	Re. Nr.	Zeichnung	Gewicht	Zubehör
Marque de la machine	Code original	Ref. Nr.	Dessin	Poids	Accessoires
				gr	

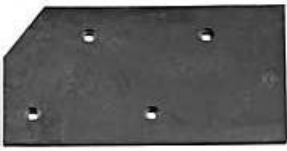
ER.MO

VOMERE PER CORPO 4ML - SPESSORE 10	CA031AD-GS8 CA031AS-GS8	VA008 DX VA015 SX		7.000	BUL14
VERSOIO PER CORPO 4ML - SPESSORE 8	CA099AD-4ML CA099AS-4ML	VA019 DX VA020 SX		30.400	-
VERSOIO PER AVANVOMERE - SPESSORE 8	CA054AD-A26 CA054AS-A26	VA021 DX VA022 SX		1.700	-
VERSOIO PER AVANVOMERE - SPESSORE 10	CA031AD-A30 CA031AS-A30	VA023 DX VA024 SX		1.700	-
VEROSIO SPESSORE 7	CA097AD CA097AS	VA031 DX VA032 SX		21	-
COLTRO PER CORPO 4ML - SPESSORE 10	CA016AD-GS2 CA016AS-GS2	VA025 DX VA026 SX		3.000	BUL14
SUOLA PER CORPO 4ML - SPESSORE 10	CA037AD-C10 CA037AS-C10	VA027 DX VA028 SX		4.000	-
SUOLA PER CORPO 4ML - SPESSORE 10	CA07AD-C10M CA07AS-C10M	VA043 DX VA044 SX		7.000	-
SUOLA PER CORPO 4ML - SPESSORE 10	CA076AD-C12 CA076AS-C12	VA045 DX VA046 SX		16.000	-







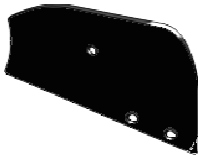

Marca/Modello	Rif. Originale	Codice	Disegno	Peso	Accessori
Machine brand name	Original code	Ref. Nr.	Draw	Weight	Accessories
Marke Maschine	Original-Code	Re. Nr.	Zeichnung	Gewicht	Zubehör
Marque de la machine	Code original	Ref. Nr.	Dessin	Poids	Accessoires
				gr	

GREGOIRE BESSON

PUNTA PER CORPO B2- C14S - B2 - B3-CV7 - SPESSORE 15	173332-173331	VG100 DX VG101 SX		2.040	-
VOMERE PER AVANVOMERE - SPESSORE 12	19114 - 19113	VG102 DX VG103 SX		1.500	-
VOMERE PER AVANVOMERE - SPESSORE 10	19112 - 19111	VG104 DX VG105 SX		2.000	-
VOMERE PER AVANVOMERE - SPESSORE 10	19126 - 19125	VG106 DX VG107 SX		1.470	-
PREVERSOIO PER CORPO B3-CV7 - SPESSORE 8	178114 - 1781113	VG108 DX VG109 SX		3.700	-
PREVERSOIO PER CORPO B2 - SPESSORE 8	173462 - 173461	VG110 DX VG111 SX		2.000	-
VERSOIO PER CORPO B2 - SPESSORE 8	173428-173429 - 173460-73427 - 173491-73459	VG112 DX VG113 SX		20.400	-
VERSOIO PER AVANVOMERE - SPESSORE 6	19116 - 19115	VG114 DX VG115 SX		2.000	-
VERSOIO PER AVANVOMERE - SPESSORE 6	19172 - 19171	VG116 DX VG117 SX		2.000	-

Marca/Modello	Rif. Originale	Codice	Disegno	Peso	Accessori
Machine brand name	Original code	Ref. Nr.	Draw	Weight	Accessories
Marke Maschine	Original-Code	Re. Nr.	Zeichnung	Gewicht	Zubehör
Marque de la machine	Code original	Ref. Nr.	Dessin	Poids	Accessoires
				gr	

GREGOIRE BESSON

VERSOIO PER AVANVOMERE - SPESSORE 6	19188 - 19187	VG118 DX VG119 SX		2.700	-
VERSOIO PER AVANVOMERE - SPESSORE 7	19168 - 19167	VG120 DX VG121 SX		2.000	-
VERSOIO PER CORPO B2-C14S - SPESSORE 8	173404 - 173480 - 173403 - 173479	VG122 DX VG123 SX		13.330	-
STRISCIA PER CORPO B3-CV7 - SPESSORE 10	178106 - 178105	VG124 DX VG125 SX		2.940	-
STRISCIA PER CORPO B3-CV7 - SPESSORE 10	178108 - 178107	VG126 DX VG127 SX		2.790	-
STRISCIA PER CORPO B3-CV7 - SPESSORE 10	178110 - 178109	VG128 DX VG129 SX		3.740	-
STRISCIA PER CORPO B3-CV7 - SPESSORE 10	178112 - 178111	VG130 DX VG131 SX		6.100	-
PROLUNGA VERSOIO PER CORPO B2 - SPESSORE 10	172312 - 172311	VG132 DX VG133 SX		1.790	-
PROLUNGA VERSOIO PER CORPO B2-C14S - SPESSORE 10	172348 - 172347	VG134 DX VG135 SX		2.120	-

Marca/Modello	Rif. Originale	Codice	Disegno	Peso	Accessori
Machine brand name	Original code	Ref. Nr.	Draw	Weight	Accessories
Marke Maschine	Original-Code	Re. Nr.	Zeichnung	Gewicht	Zubehör
Marque de la machine	Code original	Ref. Nr.	Dessin	Poids	Accessoires
				gr	

GREGOIRE BESSON









SUOLA PER CORPO B2-C14S - B2 - B3-CV7 - SPESSORE 12	177319	VG136		6.000	-
SUOLA PER CORPO B2-C14S - B2 - B3-CV7 - SPESSORE 12	173388	VG137		5.000	-
SUOLA PER CORPO B2-C14S - B2 - B3-CV7 - SPESSORE 12	177349	VG138		2.910	-

KUHN

PUNTA PER CORPO H4 - H6 - N4 - SK - VL - V-LP	622128 622129	VK001 DX VK002 SX		1.840	-
VOMERE PER AVANVOMERE - SPESSORE 6	619126 619127	VK003 DX VK004 SX		2.350	-
VOMERE PER AVANVOMERE - SPESSORE 8	631102 631103	VK005 DX VK006 SX		1.220	-
VOMERE PER AVANVOMERE - SPESSORE 6	618104 618105	VK107 DX VK007 SX		1.940	-
VOMERE PER AVANVOMERE - SPESSORE 10	631100 631101	VK008 DX VK009 SX		1.350	-
VOMERE PER AVANVOMERE - SPESSORE 6	619130 619131	VK010 DX VK011 SX		3.100	-

Marca/Modello	Rif. Originale	Codice	Disegno	Peso	Accessori
Machine brand name	Original code	Ref. Nr.	Draw	Weight	Accessories
Marke Maschine	Original-Code	Re. Nr.	Zeichnung	Gewicht	Zubehör
Marque de la machine	Code original	Ref. Nr.	Dessin	Poids	Accessoires
				gr	

KUHN

VOMERE PER AVANVOMERE - SPESSORE 6	619132 619133	VK012 DX VK013 SX		3.940	-
VOMERE PER AVANVOMERE - SPESSORE 10	631108 631109	VK014 DX VK015 SX		1.460	-
VOMERE PER AVANVOMERE - SPESSORE 10	631112	VK016		1.000	-
PREVERSOIO PER CORPO H4 - SPESSORE 4	619120 619121	VK017 DX VK018 SX		2.100	-
PREVERSOIO PER CORPO VL - SPESSORE 7	H0403520 H0403530	VK019 DX VK020 SX		2.400	-
PREVERSOIO PER CORPO SK - SPESSORE 12	619278 619279	VK021 DX VK022 SX		2.050	-
PREVERSOIO PER CORPO SK - SPESSORE 12	619278 619279	VK021 DX VK022 SX		2.050	-
PREVERSOIO PER CORPO N4 - SPESSORE 7	619200 619201	VK023 DX VK024 SX		1.420	-
PREVERSOIO PER CORPO V-LP - SPESSORE 7	619060 619061	VK025 DX VK026 SX		1.390	-

Marca/Modello	Rif. Originale	Codice	Disegno	Peso	Accessori
Machine brand name	Original code	Ref. Nr.	Draw	Weight	Accessories
Marke Maschine	Original-Code	Re. Nr.	Zeichnung	Gewicht	Zubehör
Marque de la machine	Code original	Ref. Nr.	Dessin	Poids	Accessoires
				gr	

KUHN

VERSOIO PER CORPO H4 - SPESSORE 7	612108 612109	VK027 DX VK028 SX		16.900	-
VERSOIO PER CORPO SK - SPESSORE 7	616242 616243	VK029 DX VK030 SX		19.500	-
VERSOIO PER CORPO H6 - SPESSORE 7	612110 612111	VK031 DX VK032 SX		1.900	-
PREVERSOIO PER CORPO V-LP - SPESSORE 7	619060 619061	VK033 DX VK034 SX		17.000	-
STRISCIA PER CORPO VL - SPESSORE 10	H0403180 H0403190	VK035 DX VK036 SX		4.000	-
STRISCIA PER CORPO VL - SPESSORE 10	H0403200 H0403210	VK037 DX VK038 SX		4.300	-
STRISCIA PER CORPO VL - SPESSORE 10	H0403220 H0403230	VK039 DX VK040 SX		5.050	-
STRISCIA PER CORPO VL - SPESSORE 10	H0403240 H0403250	VK041 DX VK042 SX		7.250	-
STRISCIA PER CORPO V-LP - SPESSORE 10	617102 617103	VK043 DX VK044 SX		4.420	-



Marca/Modello	Rif. Originale	Codice	Disegno	Peso	Accessori
Machine brand name	Original code	Ref. Nr.	Draw	Weight	Accessories
Marke Maschine	Original-Code	Re. Nr.	Zeichnung	Gewicht	Zubehör
Marque de la machine	Code original	Ref. Nr.	Dessin	Poids	Accessoires
				gr	

KUHN







STRISCIA PER CORPO V-LP - SPESSORE 10	617104 617105	VK045 DX VK046 SX		3.420	-
STRISCIA PER CORPO V-LP - SPESSORE 10	617106 617107	VK047 DX VK048 SX		3.210	-
STRISCIA PER CORPO V-LP - SPESSORE 10	617100 617101	VK049 DX VK050 SX		3.740	-
ALETTA DI INTERRAMENTO PER CORPO H4 - H6 - N4 - SPESSORE 8	619122 619123	VK051 DX VK052 SX		2.900	-
PROLUNGA VERSOIO PER CORPO H4 - H6 - N4 - SPESSORE 8	648102 648103	VK053 DX VK054 SX		1.900	-
SUOLA PER CORPO V-LP - SPESSORE 10	761110 761111	VK055 DX VK056 SX		800	-
SUOLA PER CORPO SK - SPESSORE 10	761216 761217	VK057 DX VK058 SX		910	-
SUOLA PER CORPO H4 - H6 - N4 - SK - V-LP - SPESSORE 10	761108	VK059		4.700	-
SUOLA PER CORPO H4 - H6 - N4 - SK - VL - V-LP - SPESSORE 10	173388	VK060		5.600	-

Marca/Modello	Rif. Originale	Codice	Disegno	Peso	Accessori
Machine brand name	Original code	Ref. Nr.	Draw	Weight	Accessories
Marke Maschine	Original-Code	Re. Nr.	Zeichnung	Gewicht	Zubehör
Marque de la machine	Code original	Ref. Nr.	Dessin	Poids gr	Accessoires

KUHN









SUOLA PER CORPO H4 - N4 - SPESSORE 10	278076 278077	VK061 DX VK062 SX		2.960	-
SUOLA PER CORPO H4 - N4 - SPESSORE 10	278074 278075	VK063 DX VK064 SX		4.670	-

KVERNELAND

PUNTA PER CORPO 8 - 9 - 19 - 28 - 30 - SPESSORE 12	KK053090 KK063090	VK065 DX VK066 SX		1.260	-
PUNTA PER CORPO 8 - 9 - 19 - 28 - 30 - SPESSORE 15	KK053090 KK063090	VK067 DX VK068 SX		1.680	-
VOMERE PER AVANVOMERE - SPESSORE 5	KK076812 KK076813	VK069 DX VK070 SX		3.100	-
VOMERE PER AVANVOMERE - SPESSORE 4	KK066880 KK066881	VK071 DX VK072 SX		1.400	-
VOMERE PER AVANVOMERE - SPESSORE 8	KK056873 KK066873	VK073 DX VK074 SX		1.070	-
VOMERE PER AVANVOMERE - SPESSORE 8	KK066868 KK066869	VK075 DX VK076 SX		1.530	-
PREVERSOIO PER CORPO 19 - 30 - SPESSORE 8	KK073220 KK073231	VK077 DX VK078 SX		1.750	-







Marca/Modello	Rif. Originale	Codice	Disegno	Peso	Accessori
Machine brand name	Original code	Ref. Nr.	Draw	Weight	Accessories
Marke Maschine	Original-Code	Re. Nr.	Zeichnung	Gewicht	Zubehör
Marque de la machine	Code original	Ref. Nr.	Dessin	Poids	Accessoires
				gr	

KVERNELAND



PREVERSOIO PER CORPO 9 - SPESSORE 8	KK073256 KK073257	VK079 DX VK080 SX		1.500	-
PREVERSOIO PER CORPO 8 - 28 - SPESSORE 8	KK073250 KK073251	VK081 DX VK082 SX		1.370	-
VERSOIO PER CORPO 8 - SPESSORE 8	KK073286 KK073287	VK083 DX VK084 SX		19.550	-
VERSOIO PER CORPO 9 - 19 - SPESSORE 8	KK073290 KK073291	VK085 DX VK086 SX		19.600	-
PREVERSOIO PER CORPO 28 - SPESSORE 8	KK083228 KK083229	VK087 DX VK088 SX		25.200	-
VERSOIO PER CORPO 8- SPESSORE 8	KK073280 KK073281	VK089 DX VK090 SX		17.200	-
STRISCIA PER CORPO 30 - SPESSORE 12	KK083211 KK083221	VK091 DX VK092 SX		6.950	-
STRISCIA PER CORPO 30 - SPESSORE 12	KK083212 KK083222	VK093 DX VK094 SX		5.300	-
STRISCIA PER CORPO 30 - SPESSORE 12	KK083213 KK083223	VK095 DX VK096 SX		4.400	-

Marca/Modello	Rif. Originale	Codice	Disegno	Peso	Accessori
Machine brand name	Original code	Ref. Nr.	Draw	Weight	Accessories
Marke Maschine	Original-Code	Re. Nr.	Zeichnung	Gewicht	Zubehör
Marque de la machine	Code original	Ref. Nr.	Dessin	Poids	Accessoires
				gr	

KVERNELAND









STRISCIA PER CORPO 30 - SPESSORE 12	KK083214 KK083224	VK097 DX VK098 SX		3.640	-
COLTRO PER CORPO 8 - 9 - 19 - 28 - 30 - SPESSORE 9	KK084320 KK084321	VK099 DX VK100 SX		3.080	-
COLTRO DA BASSO PER CORPO 8 - 9 - 19 - 28 - 30 - SPESSORE 4	KK073091 KK073092	VK101 DX VK102 SX		810	-
SUOLA PER CORPO 8 - 9 - 19 - 28 - 30 - SPESSORE 11	KK073608	VK103		5.270	-
SUOLA PER CORPO 8 - 9 - 19 - 28 - 30 - SPESSORE 11	KK073609	VK104		7.910	-
SUOLA PER CORPO 8 - 9 - 19 - 28 - 30 - SPESSORE 10	KK063-073310 KK063-073311	VK105 DX VK106 SX		2.120	-

LEMKEN

PUNTA PER CORPO C40 - CS40 - SPESSORE 12	3365540 3365541	VL100 DX VL101 SX		2.000	-
PUNTA PER CORPO B30 - B35 - B40 - BS20 - BS40 - SPESSORE 16	3364050 3364051	VL102 DX VL103 SX		2.030	-
PUNTA PER CORPO B30 - B35 - B40 - BS20 - BS40 - SPESSORE 16 - CON RIPORTO	3364150 3364151	VL102R DX VL103R SX		2.000	-

Marca/Modello	Rif. Originale	Codice	Disegno	Peso	Accessori
Machine brand name	Original code	Ref. Nr.	Draw	Weight	Accessories
Marke Maschine	Original-Code	Re. Nr.	Zeichnung	Gewicht	Zubehör
Marque de la machine	Code original	Ref. Nr.	Dessin	Poids	Accessoires
				gr	

LEMKEN

PUNTA PER CORPO B30 - B35 - B40 - BS40 - BS42 - C40 - SPESSORE 10	3401900 3401901	VL104 DX VL105 SX		1.000	-
PUNTA PER CORPO B30 - B35 - B40 - BS20 - BS40 - SPESSORE 15	3363986 3363987	VL106 DX VL107 SX		1.880	-
PUNTA PER CORPO B30 - B35 - B40 - BS20 - BS40 - SPESSORE 12	3363980 3363981	VL108 DX VL109 SX		1.440	-
VOMERE PER CORPO CS40 - SPESSORE 11	3352134 3352135	VL110 DX VL111 SX		5.150	-
VOMERE PER CORPO CS40 - SPESSORE 11 CON RIPOORTO	3352134 3352135	VL110R DX VL111R SX		5.300	-
VOMERE PER CORPO B35 - B40 - SPESSORE 11	3352130 3352131	VL112 DX VL113 SX		4.610	-
VOMERE PER CORPO B35 - B40 - SPESSORE 11	3352230 3352231	VL114 DX VL115 SX		5.300	-
VOMERE PER CORPO B30 - BS20 - BS40 - C40 - SPESSORE 11	3352120 3352121	VL116 DX VL117 SX		4.000	-
VOMERE PER AVANVOMERE SPESSORE 8	3363712 3363713	VL118 DX VL119 SX		840	-



Marca/Modello	Rif. Originale	Codice	Disegno	Peso	Accessori
Machine brand name	Original code	Ref. Nr.	Draw	Weight	Accessories
Marke Maschine	Original-Code	Re. Nr.	Zeichnung	Gewicht	Zubehör
Marque de la machine	Code original	Ref. Nr.	Dessin	Poids	Accessoires
				gr	

LEMKEN

VOMERE PER AVANVOMERE SPESSORE 8	3363720 3363721	VL120 DX VL121 SX		1.010	-
VOMERE PER AVANVOMERE SPESSORE 8	3363724	VL122		1.500	-
VOMERE PER AVANVOMERE SPESSORE 8	3366710 3366711	VL123 DX VL124 SX		1.400	-
PREVERSOIO PER CORPO B30 - B35 - B40 - BS40 - SPESSORE 8	3451000 3451001	VL125 DX VL126 SX		2.380	-
PREVERSOIO PER CORPO C40 - CS40 - SPESSORE 7	3451004 3451005	VL127 DX VL128 SX		1.900	-
PREVERSOIO PER CORPO B30 - B35 - B40 - BS20 - BS40 - BS42 - SPESSORE 8	3451010 3451011	VL129 DX VL130 SX		2.600	-
VERSOIO PER CORPO B40 - SPESSORE 8	3441040 3441041	VL131 DX VL132 SX		18.140	-
VERSOIO PER CORPO B40 - SPESSORE 7	3441140 3441141	VL133 DX VL134 SX		17.350	-
VERSOIO PER AVANVOMERE SPESSORE 5	3470620 3470621	VL135 DX VL136 SX		2.240	-









Marca/Modello	Rif. Originale	Codice	Disegno	Peso	Accessori
Machine brand name	Original code	Ref. Nr.	Draw	Weight	Accessories
Marke Maschine	Original-Code	Re. Nr.	Zeichnung	Gewicht	Zubehör
Marque de la machine	Code original	Ref. Nr.	Dessin	Poids	Accessoires
				gr	

LEMKEN

VERSOIO PER AVANVOMERE SPESSORE 5	3470600 3470601	VL137 DX VL138 SX		3.970	-
STRISCIA PER CORPO BS20 - BS40 - BS42 - SPESSORE 10	3444010 3444011	VL139 DX VL140 SX		2.970	-
STRISCIA PER CORPO BS40 - BS42 - SPESSORE 10	3444020 3444021	VL141 DX VL142 SX		3.280	-
STRISCIA PER CORPO BS40 - BS42 - SPESSORE 10	3444030 3444031	VL143 DX VL144 SX		4.720	-
STRISCIA PER CORPO BS42 - SPESSORE 10	3444042 3444043	VL145 DX VL146 SX		7.200	-
STRISCIA PER CORPO BS20 - BS40 - BS42 SPESSORE 10	3444012 3444013	VL147 DX VL148 SX		4.770	-
STRISCIA PER CORPO BS20 SPESSORE 10	3444034 3444035	VL149 DX VL150 SX		3.980	-
STRISCIA PER CORPO BS20 SPESSORE 12	3444044 3444045	VL151 DX VL152 SX		4.390	-
STRISCIA PER CORPO BS20 SPESSORE 10	3444024 3444025	VL171 DX VL153 SX		3.140	-



Marca/Modello	Rif. Originale	Codice	Disegno	Peso	Accessori
Machine brand name	Original code	Ref. Nr.	Draw	Weight	Accessories
Marke Maschine	Original-Code	Re. Nr.	Zeichnung	Gewicht	Zubehör
Marque de la machine	Code original	Ref. Nr.	Dessin	Poids	Accessoires
				gr	

LEMKEN







TRISCIA PER CORPO CS40 SPESSORE 10	3444018 3444019	VL154 DX VL155 SX		3.650	-
STRISCIA PER CORPO CS40 SPESSORE 12	3444028 3444029	VL156 DX VL157 SX		3.530	-
STRISCIA PER CORPO CS40 SPESSORE 12	3444038 3444039	VL158 DX VL159 SX		4.080	-
STRISCIA PER CORPO CS40 SPESSORE 10	3444048 3444049	VL160 DX VL161 SX		5.100	-
PROLUNGA VERSOIO PER CORPO B30 - B35 - B40 - C40 - SPESSORE 8	3476000 3476001	VL162 DX VL163 SX		1.340	-
COLTRO PER CORPO B30 - B35 - B40 - C40 - CS40 SPESSORE 6	3492890 3492891	VL164 DX VL165 SX		1.360	-
SUOLA PER CORPO B30 - B35 - B40 - BS40 - BS42 - C40 - CS40 SPESSORE 12	3411504	VL166		4.640	-
SUOLA PER CORPO B30 - B35 - B40 - BS20 - BS40 - BS42 SPESSORE 12	3411508	VL167		5.900	-
SUOLA PER CORPO C40 - CS40 SPESSORE 12	3411450	VL168		5.240	-

Marca/Modello	Rif. Originale	Codice	Disegno	Peso	Accessori
Machine brand name	Original code	Ref. Nr.	Draw	Weight	Accessories
Marke Maschine	Original-Code	Re. Nr.	Zeichnung	Gewicht	Zubehör
Marque de la machine	Code original	Ref. Nr.	Dessin	Poids	Accessoires
				gr	

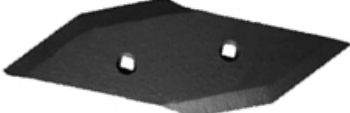
LEMKEN

SUOLA PER CORPO B30 - B35 - B40 - BS20 - BS40 - BS42 - C40 - CS40 SPESSORE 12	3411460	VL169		6.860	-
SUOLA PER CORPO B30 - B35 - B40 - BS20 - BS40 - BS42 SPESSORE 12	3411500	VL170		4.000	-

NARDI

PUNTA PER CORPO SPESSORE 12	3054502	VN001 DX VN002 SX		2.070	-
PUNTA PER CORPO CN8 SPESSORE 12	8C60	VN003 DX VN004 SX		4.000	-
PUNTA PER CORPO EN6/CN7/EN7 SPESSORE 12	5C60	VN005 DX VN006 SX		2.250	-
VOMERE PER CORPO SPESSORE 10	3054452	VN007 DX VN008 SX		6.530	-
VOMERE PER CORPO SPESSORE 15	6C20	VN009 DX VN010 SX		5.000	-
VOMERE PER CORPO SPESSORE 15	7C60	VN011 DX VN012 SX		2.650	-
VOMERE PER CORPO CN8 SPESSORE 12	8C35	VN013 DX VN014 SX		5.000	-



Marca/Modello	Rif. Originale	Codice	Disegno	Peso	Accessori
Machine brand name	Original code	Ref. Nr.	Draw	Weight	Accessories
Marke Maschine	Original-Code	Re. Nr.	Zeichnung	Gewicht	Zubehör
Marque de la machine	Code original	Ref. Nr.	Dessin	Poids	Accessoires
				gr	

NARDI

VOMERE PER CORPO EN6/CN7/EN7 - UN6/UN7 SPESSORE 10	7C35	VN015 DX VN016 SX		4.380	-
PREVERSOIO PER CORPO CN8 SPESSORE 7	8C192	VN017 DX VN018 SX		1.000	-
VERSOIO CORPO SPESSORE 7	3022354	VN019 DX VN020 SX		15.550	-
VERSOIO PER CORPO CN8 SPESSORE 7	8C1205	VN021 DX VN022 SX		16.030	-
PROLUNGA VERSOIO PER CORPO CN8 SPESSORE 7	7C181	VN023 DX VN024 SX		2.000	-
COLTRO PER CORPO CN8 - EN6/CN7/EN7 - UN6/UN7 SPESSORE 8	6C275	VN025 DX VN026 SX		2.000	-
SUOLA PER CORPO SPESSORE 10	3065501GD	VN027		3.620	-
SUOLA PER CORPO UN6/UN7 SPESSORE 12	6C140	VN028 DX VN029 SX		7.000	-
SUOLA PER CORPO CN8 SPESSORE 10	8C142	VN030 DX VN031 SX		4.000	-

Marca/Modello	Rif. Originale	Codice	Disegno	Peso	Accessori
Machine brand name	Original code	Ref. Nr.	Draw	Weight	Accessories
Marke Maschine	Original-Code	Re. Nr.	Zeichnung	Gewicht	Zubehör
Marque de la machine	Code original	Ref. Nr.	Dessin	Poids	Accessoires
				gr	

NARDI

SUOLA PER CORPO UN6/UN7 SPESSORE 12	6C140	VN032 DX VN033 SX		7.000	-
SUOLA PER CORPO EN6/CN7/EN7 SPESSORE 10	6C142	VN034 DX VN035 SX		3.910	-

RABEWERK

PUNTA PER CORPO BP- 321 PS / BP-322PS - BP- 323 PS - BP-350 WS SPESSORE 12	27011201- MP293	VR001 DX VR002 SX		1.200	-
PREVERSOIO PER CORPO BP-321 PS / BP- 322PS - BP-323 PS SPESSORE 8	27002201- VPR342	VR003 DX VR004 SX		1.870	-
PREVERSOIO PER CORPO BP-350 WS SPESSORE 8	27510501- WRP350W	VR005 DX VR006 SX		2.140	-
STRISCIA PER CORPO BP- 321 PS / BP-322PS - BP- 323 PS SPESSORE 12	27310901- SRP328P1	VR007 DX VR008 SX		3.300	-
STRISCIA PER CORPO BP- 321 PS / BP-322PS - BP- 323 PS SPESSORE 12	27311001- SRP328P2	VR009 DX VR010 SX		3.700	-
STRISCIA PER CORPO BP- 321 PS / BP-322PS - BP- 323 PS SPESSORE 12	27311101- SRP328P3	VR011 DX VR012 SX		5.770	-
STRISCIA PER CORPO BP- 321 PS / BP-322PS - BP- 323 PS SPESSORE 12	27311201- SRP328P4	VR013 DX VR014 SX		5.200	-

Marca/Modello	Rif. Originale	Codice	Disegno	Peso	Accessori
Machine brand name	Original code	Ref. Nr.	Draw	Weight	Accessories
Marke Maschine	Original-Code	Re. Nr.	Zeichnung	Gewicht	Zubehör
Marque de la machine	Code original	Ref. Nr.	Dessin	Poids	Accessoires
				gr	

RABEWERK

STRISCIA PER CORPO BP-323 PS SPESSORE 12	27311201-SRP327PB4 27311201-SRP327PL4	VR015 DX VR016 SX		8.000	-
STRISCIA PER CORPO BP-350 WS SPESSORE 12	27550301-SRP350W3	VR017 DX VR018 SX		5.860	-
STRISCIA PER CORPO BP-350 WS SPESSORE 12	27550201-SRP350W2	VR019 DX VR020 SX		4.500	-
STRISCIA PER CORPO BP-350 WS SPESSORE 12	27550101-SRP350W1	VR021 DX VR022 SX		3.800	-
STRISCIA PER CORPO BP-350 WS SPESSORE 12	27550701-SRP350W41	VR023 DX VR024 SX		8.100	-
SUOLA PER CORPO BP-321 PS / BP-322PS - BP-323 PS SPESSORE 14	27011400-WP2920	VR025		6.420	-
SUOLA PER CORPO BP-321 PS / BP-322PS - BP-323 PS SPESSORE 8	27081500-XP4	VR026		900	-
SUOLA PER CORPO BP-350 WS SPESSORE 12	27510306-VP351W	VR027		5.700	-
SUOLA PER CORPO BP-350 WS SPESSORE 8	27510305-WP351W	VR028		5.700	-

Marca/Modello	Rif. Originale	Codice	Disegno	Peso	Accessori
Machine brand name	Original code	Ref. Nr.	Draw	Weight	Accessories
Marke Maschine	Original-Code	Re. Nr.	Zeichnung	Gewicht	Zubehör
Marque de la machine	Code original	Ref. Nr.	Dessin	Poids	Accessoires
				gr	

RABEWERK

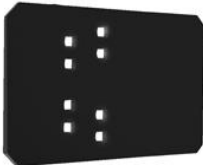

SUOLA PER CORPO BP-321 PS / BP-322PS - BP-323 PS SPESSORE 8	27071400-VP2920	VR029		2.000	-
SUOLA PER CORPO BP-350 WS SPESSORE 8	617102-XP61	VR030		4.880	-

VOGEL & NOOT

PUNTA PER CORPO UN400 - UN430 - WY400 SPESSORE 14	PK801101 PK801102	VV001 DX VV002 SX		1.490	-
PREVERSOIO PER CORPO UN400 SPESSORE 8	PK400103 PK400203	VV003 DX VV004 SX		1.700	-
PREVERSOIO PER CORPO UN430 SPESSORE 8	PK500203 PK500103	VV005 DX VV006 SX		1.940	-
PREVERSOIO PER CORPO WY400 SPESSORE 8	PK800501 PK800601	VV007 DX VV008 SX		2.140	-
VERSOIO PER CORPO UN400 SPESSORE 8	PK400102 PK400202	VV009 DX VV010 SX		13.700	-
VERSOIO PER CORPO UN430 SPESSORE 8	PK500102 PK500202	VV011 DX VV012 SX		18.300	-
VERSOIO PER CORPO WY400 SPESSORE 8	PK800109 PK800209	VV013 DX VV014 SX		19.500	-

Marca/Modello	Rif. Originale	Codice	Disegno	Peso	Accessori
Machine brand name	Original code	Ref. Nr.	Draw	Weight	Accessories
Marke Maschine	Original-Code	Re. Nr.	Zeichnung	Gewicht	Zubehör
Marque de la machine	Code original	Ref. Nr.	Dessin	Poids	Accessoires
				gr	

VOGEL & NOOT

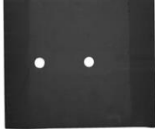
ALETTA DI INTERRAMENTO PER CORPO WY400 SPESSORE 12	PK805102 PK805202	VV015 DX VV016 SX		2.000	-
SUOLA PER CORPO UN400 - UN430 - WY400 SPESSORE 12	PK803401 PK803501	VV017 DX VV018 SX		2.000	-
SUOLA PER CORPO UN400 - UN430 - WY400 SPESSORE 12	P5801101	VV019		2.000	-

Bulloneria
Special bolts
Schrauben
Boulonnerie

Descrizione	Codice
Description	Ref. Nr.
Beschreibung	Re. Nr.
Description	Ref. Nr.
VITI QUADRO SOTTO TESTA UNI 6104 8.8 CON DADO E RONDELLA 10 X 35	BUL27
VITI QUADRO SOTTO TESTA UNI 6104 8.8 CON DADO E RONDELLA 10 X 40	BUL28
VITI QUADRO SOTTO TESTA UNI 6104 8.8 CON DADO E RONDELLA 10 X 50	BUL29
VITI QUADRO SOTTO TESTA UNI 6104 8.8 CON DADO E RONDELLA 12 X 35	BUL30
VITI QUADRO SOTTO TESTA UNI 6104 8.8 CON DADO E RONDELLA 12 X 40	BUL31
VITI QUADRO SOTTO TESTA UNI 6104 8.8 CON DADO E RONDELLA 12 X 50	BUL32
VITI QUADRO SOTTO TESTA UNI 6104 8.8 CON DADO E RONDELLA 12 X 60	BUL33
VITI QUADRO SOTTO TESTA UNI 6104 8.8 CON DADO E RONDELLA 12 X 70	BUL34
VITI QUADRO SOTTO TESTA UNI 6104 8.8 CON DADO E RONDELLA 12 X 80	BUL35
VITI QUADRO SOTTO TESTA UNI 6104 8.8 CON DADO E RONDELLA 12 X 90	BUL36
VITI QUADRO SOTTO TESTA UNI 6104 8.8 CON DADO E RONDELLA 14 X 35	BUL37
VITI QUADRO SOTTO TESTA UNI 6104 8.8 CON DADO E RONDELLA 14 X 40	BUL14
VITI QUADRO SOTTO TESTA UNI 6104 8.8 CON DADO E RONDELLA 14 X 45	BUL38
VITI QUADRO SOTTO TESTA UNI 6104 8.8 CON DADO E RONDELLA 14 X 50	BUL15
VITI QUADRO SOTTO TESTA UNI 6104 8.8 CON DADO E RONDELLA 14 X 60	BUL39
VITI QUADRO SOTTO TESTA UNI 6104 8.8 CON DADO E RONDELLA 16 X 40	BUL40
VITI QUADRO SOTTO TESTA UNI 6104 8.8 CON DADO E RONDELLA 16 X 45	BUL41
VITI QUADRO SOTTO TESTA UNI 6104 8.8 CON DADO E RONDELLA 16 X 50	BUL42

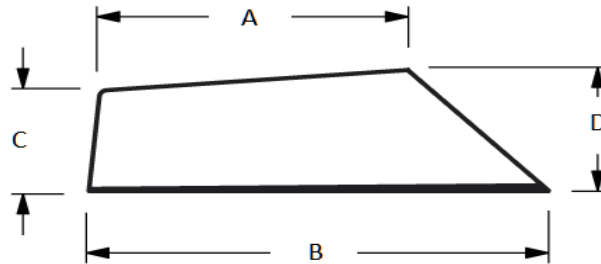

COD.	A	B	C	D	E	gr
VMR01	240	330	110	125	55°	2400
VMR02	260	350	110	125	55°	2500
VMR03	260	360	120	150	58°	3500
VMR04	280	370	110	125	55°	2600
VMR05	280	380	120	150	58°	3600
VMR06	300	390	110	125	55°	2700
VMR07	280	420	120	150	48°	3400
VMR08	300	440	120	150	48°	4000
VMR09	320	460	120	150	48°	4200
VMR10	340	480	120	150	48°	4400
VMR11	360	500	120	150	48°	4600
VMR12	380	545	145	200	50°	7500
VMR13	420	575	150	180	50°	8000
VMR14	460	575	150	180	50°	8600